



**ENERGY**



GELATO  
Gelato  
Gelato  
Gelato



PASTICCERIA  
Pastry  
Pâtisserie  
Konditorei



PRALINERIA  
Praline  
Pralinerie  
Pralinen



CALDO A SECCO  
Dry heat  
Trockene Wärme  
Chaud à sec



BAGNO MARIA  
Bain marie  
Wasserbad  
Bain marie

Totale visibilità del prodotto da ogni lato, un design elegante, moderno e deciso, la consueta affidabile tecnologia d'avanguardia Ital Proget. ENERGY è l'ideale per gelaterie e pasticcerie anche grazie alla grande flessibilità dei suoi moduli canalizzabili.

Total product visibility from all sides and a sleek, modern, bold design. The usual reliable, cutting-edge technology we've come to expect from Ital Proget. ENERGY is ideal for ice-cream and pastry shops and delicatessens thanks in part also to the great flexibility of its ductable units.

Visibilité totale du produit sur chaque côté, design élégant, moderne et affirmé, la technologie fiable et d'avant-garde habituelle d'Ital Proget. ENERGY est le produit idéal pour les glaciers, et les pâtisseries, aussi grâce à la grande flexibilité de ses modules canalisables.

Von allen Seiten sichtbares Produkt, elegantes Design, modern und schlüssig, mit der üblichen, avantgardistischen und zuverlässigen Technologie von Ital Proget. ENERGY ist perfekt für Eisdielen, Konditoreien. Dies auch dank der Flexibilität der kanalisierbaren Baueinheiten.



GELATO  
Gelato  
Gelato  
Gelato

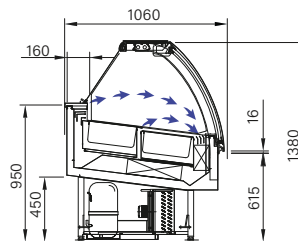
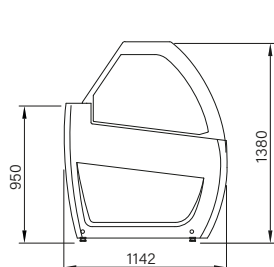

**12**

**18**

**24**

**45°AP**

Con vaschette **STANDARD**: 5Lt - 7Lt

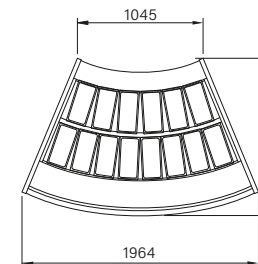
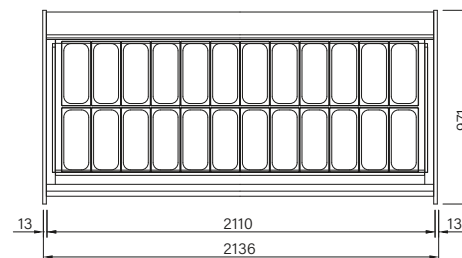
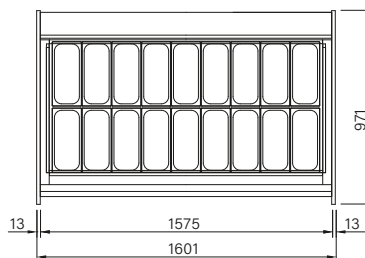
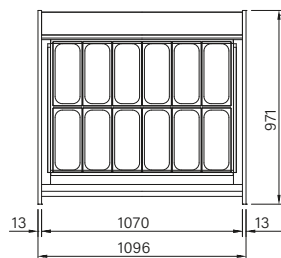

Con vaschette **LARGE**: 5,4Lt - 8Lt - 11Lt

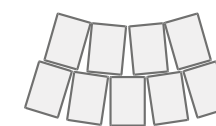
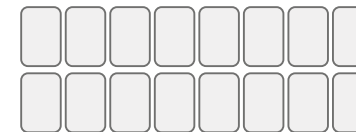
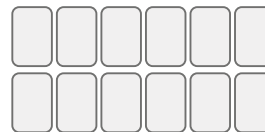
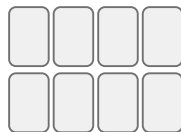

Mod.	12	18	24	45°AP
<b>DIMENSIONI / DIMENSIONS / TAILLE / GRÖSSE</b>				
Lunghezza / Length / Longueur / Länge [mm]	1096	1601	2136	1964
Profondità / Depth / Profondeur / Tiefe [mm]	1142	1142	1142	1142
Altezza / Height / Hauteur / Höhe [mm]	1380	1380	1380	1380
<b>PESO / WEIGHT / POIDS / GEWICHT [kg]</b>				
	245	335	400	335
<b>IMBALLO / EMBALLAGE / PACKAGING / VERPACKUNG</b>				
Lunghezza / Length / Longueur / Länge [mm]	1220	1720	2260	2050
Profondità / Depth / Profondeur / Tiefe [mm]	1270	1270	1270	1390
Altezza / Height / Hauteur / Höhe [mm]	1560	1560	1560	1560
<b>POTENZA COMPRESSORE / POWER COMPRESSOR / PUISSANCE COMPRESSEUR / LEISTUNG VERDICHTER</b>				
<b>(Monofase / Single-phase / Monophasé / Einphasig)</b>				
Tensione / Supply / Tension / Spannung [V/Ph/Hz]	230/1/50	230/1/50	230/1/50	230/1/50
Potenza assorbita / Electrical power output	1,51	2,08	2,5	2,08
Puissance absorbée / Absorbierte Leistung [kW]	1,51	2,08	2,5	2,08
Sbrinamento / In Defrost / Dégivrage / Zeitgesteuerte [kW]	2,15	3,53	3,8	3,53
<b>(Trifase / Three-phase / Triphasé / Dreiphasig)</b>				
Tensione / Supply / Tension / Spannung [V/Ph/Hz]	400/3/50	400/3/50	400/3/50	400/3/50
Potenza assorbita / Electrical power output	1,3	1,97	2,8	1,97
Puissance absorbée / Absorbierte Leistung [kW]	1,3	1,97	2,8	1,97
Sbrinamento / In Defrost / Dégivrage / Zeitgesteuerte [kW]	2,52	3,87	5,1	3,87



DOUBLE AIR FLOW



-16 / -18 °C



7 (35°C - 75%UR)



**PASTICCERIA**  
Pastry  
Pâtisserie  
Konditorei



**PRALINERIA**  
Praline  
Pralinerie  
Pralinen

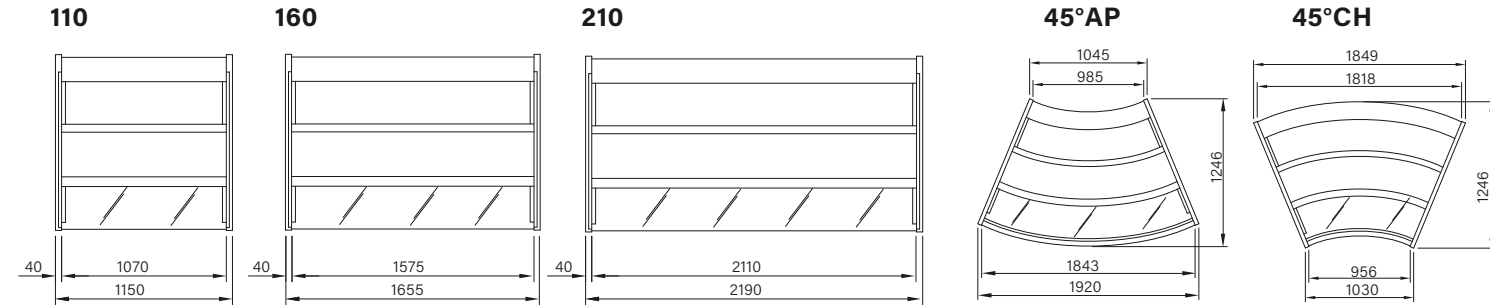
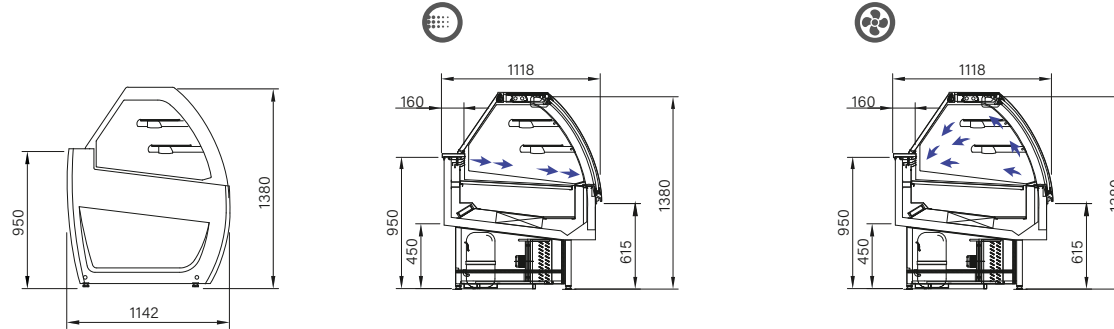

SOFT



FULL



+2 / +4 °C



4 (30°C - 55%UR)

Mod.	110	160	210	45°AP	45°CH
<b>DIMENSIONI / DIMENSIONS / TAILLE / GRÖSSE</b>					
Lunghezza / Length / Longueur / Länge [mm]	1150	1655	2190	1920	1849
Profondità / Depth / Profondeur / Tiefe [mm]	1142	1142	1142	1142	1142
Altezza / Height / Hauteur / Höhe [mm]	1380	1380	1380	1380	1380
<b>PESO / WEIGHT / POIDS / GEWICHT [kg]</b>	224	295	347	314	314
<b>IMBALLO / EMBALLAGE / PACKAGING / VERPACKUNG</b>					
Lunghezza / Length / Longueur / Länge [mm]	1220	1720	2260	2050	2050
Profondità / Depth / Profondeur / Tiefe [mm]	1270	1270	1270	1390	1390
Altezza / Height / Hauteur / Höhe [mm]	1560	1560	1560	1560	1560
<b>POTENZA COMPRESSORE / POWER COMPRESSOR / PUISSANCE COMPRESSEUR / LEISTUNG VERDICHTER</b>					
(Monofase / Single-phase / Monophasé / Einphasig)					
Tensione / Supply / Tension / Spannung [V/Ph/Hz]	230/1/50	230/1/50	230/1/50	230/1/50	230/1/50
Potenza assorbita / Electrical power output Puissance absorbée / Absorbierte Leistung [kW]	0,66	0,85	1,1	0,66	0,66
Sbrinamento / In Defrost / Dégivrage / Zeitgesteuerte [kW]	-	-	-	-	-



**CALDO A SECCO**  
Dry heat  
Trockene Wärme  
Chaud à sec

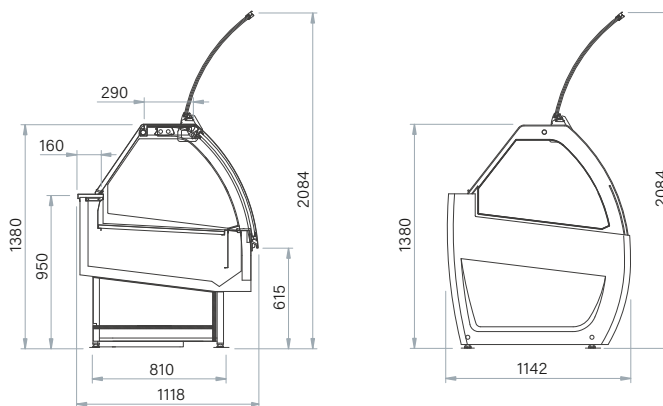

**110**

**160**

**210**

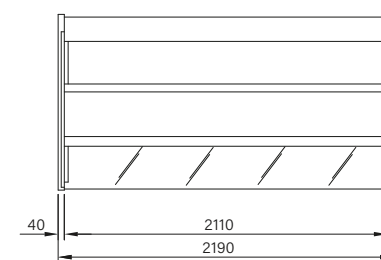
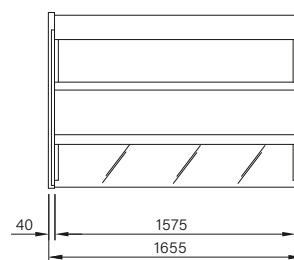
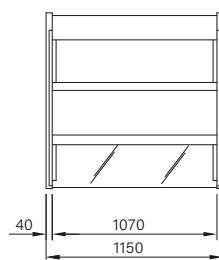

**Mod.**

**110**

**160**

**210**

**DIMENSIONI / DIMENSIONS / TAILLE / GRÖSSE**

Lunghezza / Length / Longueur / Länge [mm]	1120	1601	2136
Profondità / Depth / Profondeur / Tiefe [mm]	1120	1120	1120
Altezza / Height / Hauteur / Höhe [mm]	1380	1380	1380

<b>PESO / WEIGHT / POIDS / GEWICHT [kg]</b>	203	273	325
---	-----	-----	-----

**IMBALLO / EMBALLAGE / PACKAGING / VERPACKUNG**

Lunghezza / Length / Longueur / Länge [mm]	1220	1720	2260
Profondità / Depth / Profondeur / Tiefe [mm]	1240	1240	1240
Altezza / Height / Hauteur / Höhe [mm]	1560	1560	1560

**POTENZA COMPRESSORE / POWER COMPRESSOR / PUISSANCE COMPRESSEUR / LEISTUNG VERDICHTER**

<b>(Monofase / Single-phase / Monophasé / Einphasig)</b>			
Tensione / Supply / Tension / Spannung [V/Ph/Hz]	230/1/50	230/1/50	230/1/50
Potenza assorbita / Electrical power output Puissance absorbée / Absorbierte Leistung [kW]	0,60	1,2	1,8
Sbrinatorio / In Defrost / Dégivrage / Zeitgesteuerte [kW]	-	-	-



+40 / +60 °C



**BAGNO MARIA**  
Bain marie  
Wasserbad  
Bain marie



**VASCHETTE (standard)**  
Containers (standard)  
Conteneurs (standard)  
Schalen (standard)



+40 / +90 °C

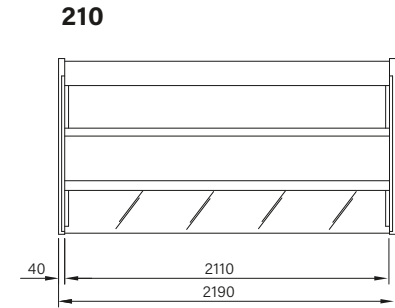
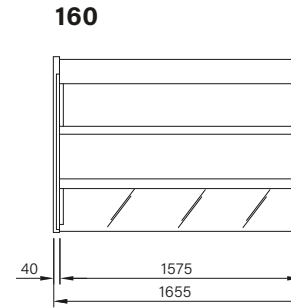
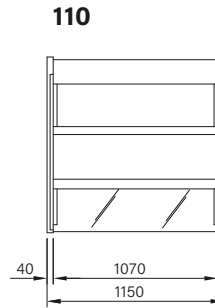
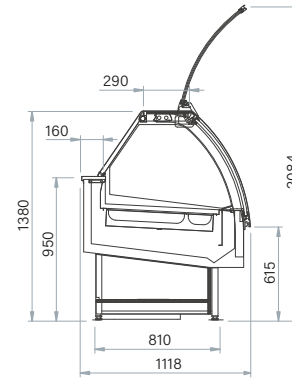
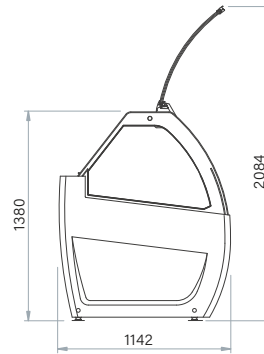

Mod.	110	160	210
<b>DIMENSIONI / DIMENSIONS / TAILLE / GRÖSSE</b>			
Lunghezza / Length / Longueur / Länge [mm]	1150	1655	2190
Profondità / Depth / Profondeur / Tiefe [mm]	1120	1120	1120
Altezza / Height / Hauteur / Höhe [mm]	1380	1380	1380
<b>PESO / WEIGHT / POIDS / GEWICHT [kg]</b>			
	203	273	325
<b>IMBALLO / EMBALLAGE / PACKAGING / VERPACKUNG</b>			
Lunghezza / Length / Longueur / Länge [mm]	1220	1720	2260
Profondità / Depth / Profondeur / Tiefe [mm]	1240	1240	1240
Altezza / Height / Hauteur / Höhe [mm]	1560	1560	1560
<b>POTENZA COMPRESSORE / POWER COMPRESSOR / PUISSANCE COMPRESSEUR / LEISTUNG VERDICHTER</b>			
<b>(Monofase / Single-phase / Monophasé / Einphasig)</b>			
Tensione / Supply / Tension / Spannung [V/Ph/Hz]	230/1/50	230/1/50	230/1/50
Potenza assorbita / Electrical power output Puissance absorbée / Absorbierte Leistung [kW]	1,5	2,4	3
Sbrinatorio / In Defrost / Dégivrage / Zeitgesteuerte [kW]	-	-	-





Follow us  
**Italproget**



**ITALPROGET**

Via Ponte di Ferro 85 – 06084 Bettona PG

Telefono: +39 075 987038

Fax: +39 075 987016

Email: [info@italproget.it](mailto:info@italproget.it)

[www.italproget.it](http://www.italproget.it)