



OMNIA



SMOOTH



POZZETTI E TOPPING



GELATO
Gelato
Gelato
Gelato



PASTICCERIA
Pastry
Pâtisserie
Konditorei



PRALINERIA
Praline
Pralinerie
Pralinen



CALDO A SECCO
Dry heat
Chaud à sec
Trockene Wärme



BAGNO MARIA
Bain marie
Bain marie
Wasserbad

Uno stile minimale e duttile capace di offrire alla clientela del locale tutto ciò che serve. Questa è l'opera OMNIA di Ital Proget; una proposta completa, un concept, un modo di pensare il proprio locale, essenziale nei tratti e nel modo di porsi ma allo stesso tempo, abile nel soddisfare in maniera ottimale l'esigenza di mostrare tutti i prodotti valorizzando il loro lato migliore: SMOOTH, POZZETTI, TOPPING questi i moduli che la compongono.

A minimal, ductile style able to offer customers everything they may need. This is OMNIA by Ital Proget: a complete offer, a new concept, a fresh way of looking at your establishment. With minimalist lines and way of presenting itself but, at the same time, able to fully satisfy all product display needs, enhancing their best side. This case is composed of the SMOOTH, POZZETTI, TOPPING units.

Un style minimaliste et ductile en mesure d'offrir tout ce qui sert à la clientèle du lieu. Voici OMNIA, l'œuvre d'Ital Proget ; une proposition complète, un concept, une façon de penser son propre lieu, un produit essentiel dans les traits et dans la manière de se placer mais au même moment habile à satisfaire de la meilleure façon qu'il soit, l'exigence de montrer tous les produits en valorisant leur meilleur côté : SMOOTH, POZZETTI, TOPPING sont les modules qui la composent.

Ein minimalistischer und anpassungsfähiger Stil mit der Fähigkeit, den Kunden des Lokals all das zu bieten, was erforderlich ist. Das ist OMNIA von Ital Proget; ein komplettes Angebot, ein Konzept und eine Vision des zigenen Lokals, nüchtern und wesentlich im Stil, aber gleichzeitig dazu in der Lage, auf Perfekter Weise sämtliche Produkte von ihrer besten Seite zu zeigen: SMOOTH, POZZETTI, TOPPING sind die verfügbaren Modelle.





H1220

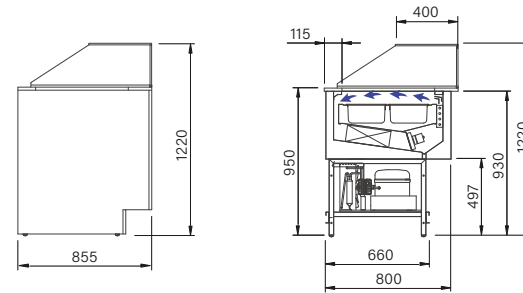

100

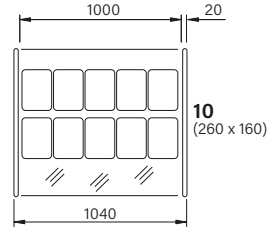

125

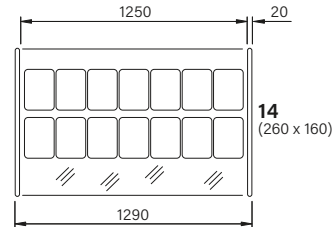

150

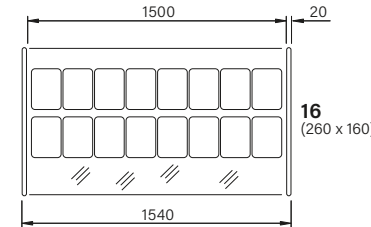

200

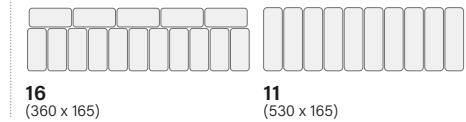
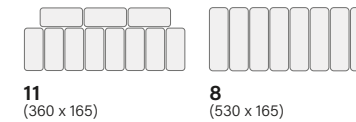
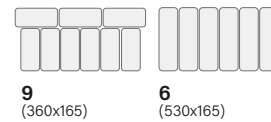
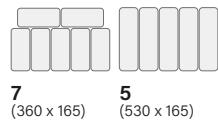
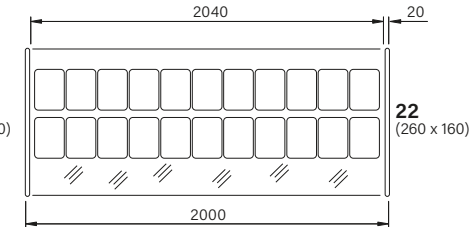

SINGLE AIR FLOW



-16 / -18 °C



3 (25°C - 60%UR)

Mod.	100	125	150	200
DIMENSIONI / DIMENSIONS / TAILLE / GRÖSSE				
Lunghezza / Length / Longueur / Länge [mm]	1040	1290	1540	2000
Profondità / Depth / Profondeur / Tiefe [mm]	855	855	855	855
Altezza / Height / Hauteur / Höhe [mm]	1220	1220	1220	1220
PESO / WEIGHT / POIDS / GEWICHT [kg]	156	160	200	260
IMBALLO / EMBALLAGE / PACKAGING / VERPACKUNG				
Lunghezza / Length / Longueur / Länge [mm]	1220	1370	1730	2220
Profondità / Depth / Profondeur / Tiefe [mm]	970	970	970	970
Altezza / Height / Hauteur / Höhe [mm]	1500	1500	1500	1500
POTENZA COMPRESSORE / POWER COMPRESSOR / PUISSANCE COMPRESSEUR / LEISTUNG VERDICHTER				
(Monofase / Single-phase / Monophasé / Einphasig)				
Tensione / Supply / Tension / Spannung [V/Ph/Hz]	230/1/50	230/1/50	230/1/50	230/1/50
Potenza assorbita / Electrical power output				
Puissance absorbée / Absorbierte Leistung [kW]	0,8	0,9	1,2	1,2
Sbrinatorio / In Defrost / Dégivrage / Zeitgesteuerte [kW]	1,05	1,43	1,43	2,19

H950

SENZA VETRI
Without glass
Sans verre
Ohne glas

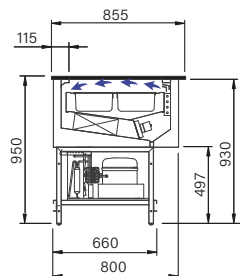

H930

SENZA VETRI E PIANO
Without glass and tray
Sans verre et plan
Ohne glas und ebne

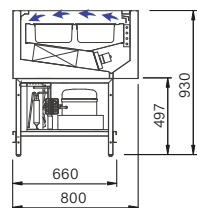

DROP IN (H430)

VETRINA GELATO CON U.C. COLLEGATA
Gelato showcase with connected condensing unit
Cuve de gelato avec unité de condensation connecté
Speiseeisvitrine zusammen mit angeschlossener kondensaggregat

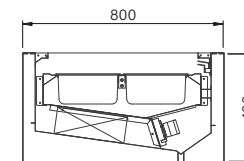

Mod.	100	125	150	200
PESO / WEIGHT / POIDS / GEWICHT [kg]	152	155	189	244
IMBALLO / EMBALLAGE / PACKAGING / VERPACKUNG				
Lunghezza / Length / Longueur / Länge [mm]	1220	1370	1730	2220
Profondità / Depth / Profondeur / Tiefe [mm]	970	970	970	970
Altezza / Height / Hauteur / Höhe [mm]	1500	1500	1500	1500

100

125

150

200

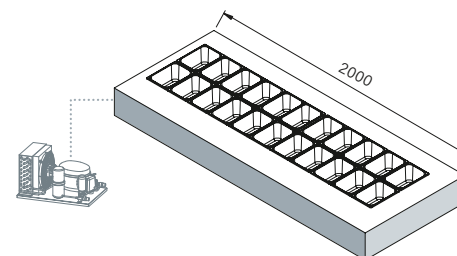
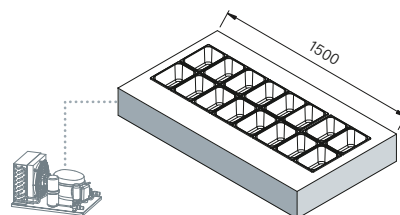
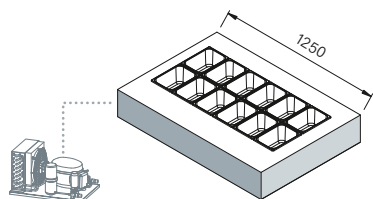
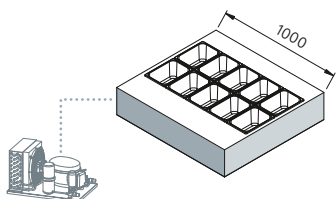

Mod.	100	125	150	200
PESO / WEIGHT / POIDS / GEWICHT [kg]	108	112	144	195
IMBALLO / EMBALLAGE / PACKAGING / VERPACKUNG				
Lunghezza / Length / Longueur / Länge [mm]	1220	1370	1730	2220
Profondità / Depth / Profondeur / Tiefe [mm]	970	970	970	970
Altezza / Height / Hauteur / Höhe [mm]	1200	1200	1200	1200



PASTICCERIA
Pastry
Pâtisserie
Konditorei



PRALINERIA
Praline
Pralinerie
Pralinen



H1220

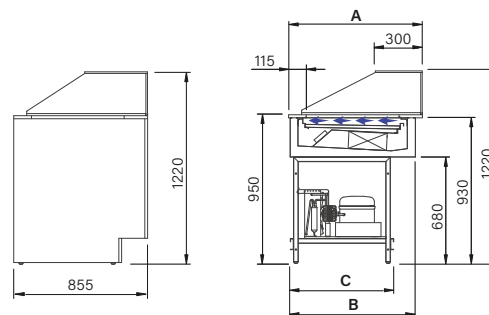

PROFONDITÀ / DEPTH / PROFONDEUR / TIEFE

	P 60	P 80	P 100
A	715	855	1055
B	660	800	1000
C	660	660	720

100

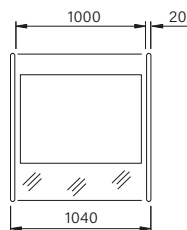

125

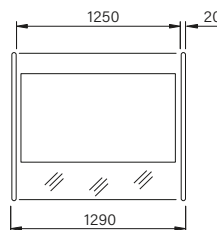

150

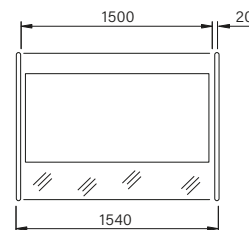

200

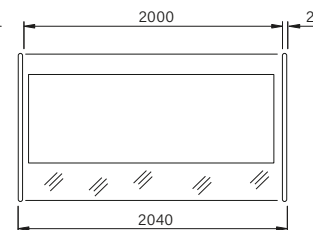

250

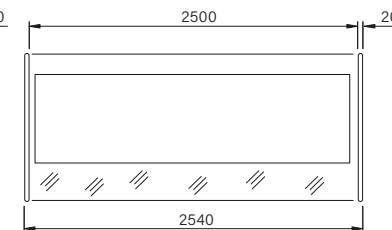

Mod.	100	125	150	200	250
DIMENSIONI / DIMENSIONS / TAILLE / GRÖSSE					
Lunghezza / Length / Longueur / Länge [mm]	1040	1290	1540	2040	2540
Profondità / Depth / Profondeur / Tiefe [mm]	A	A	A	A	A
Altezza / Height / Hauteur / Höhe [mm]	1220	1220	1220	1220	1220
PESO / WEIGHT / POIDS / GEWICHT [kg]	150	154	195	254	315
IMBALLO / EMBALLAGE / PACKAGING / VERPACKUNG					
Lunghezza / Length / Longueur / Länge [mm]	1220	1370	1730	2220	3100
Profondità / Depth / Profondeur / Tiefe [mm]	1280	1280	1280	1280	1280
Altezza / Height / Hauteur / Höhe [mm]	1500	1500	1500	1500	1500
POTENZA COMPRESSORE / POWER COMPRESSOR / PUISSANCE COMPRESSEUR / LEISTUNG VERDICHTER					
(Monofase / Single-phase / Monophasé / Einphasig)					
Tensione / Supply / Tension / Spannung [V/Ph/Hz]	230/1/50	230/1/50	230/1/50	230/1/50	230/1/50
Potenza assorbita / Electrical power output	0,42	0,48	0,76	0,8	1,15
Puissance absorbée / Absorbierte Leistung [kW]	-	-	-	-	-
Sbrinamento / In Defrost / Dégivrage / Zeitgesteuerte [kW]	-	-	-	-	-



SOFT



+2 / +4 °C



3 (25°C - 60%UR)

H950

SENZA VETRI
Without glass
Sans verre
Ohne glas

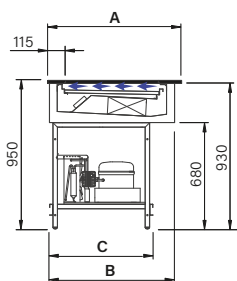

PROFONDITÀ / DEPTH
PROFONDEUR / TIEFE

	P 60	P80	P100
A	715	855	1055
B	660	800	1000
C	660	660	720

Mod.	100	125	150	200	250
------	-----	-----	-----	-----	-----

PESO / WEIGHT POIDS / GEWICHT [kg]	146	149	184	238	295
---------------------------------------	-----	-----	-----	-----	-----

IMBALLO / EMBALLAGE
PACKAGING / VERPACKUNG

Lunghezza / Length / Longueur / Länge [mm]	1220	1370	1730	2220	3100
Profondità / Depth / Profondeur / Tiefe [mm]	1280	1280	1280	1280	1280
Altezza / Height / Hauteur / Höhe [mm]	1500	1500	1500	1500	1500

H930

SENZA VETRI E PIANO
Without glass and tray
Sans verre et plan
Ohne glas und ebne

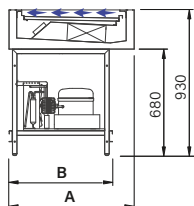

PROFONDITÀ / DEPTH
PROFONDEUR / TIEFE

	P 60	P80	P100
A	660	800	1000
B	660	660	720

Mod.	100	125	150	200	250
------	-----	-----	-----	-----	-----

PESO / WEIGHT POIDS / GEWICHT [kg]	138	141	172	225	280
---------------------------------------	-----	-----	-----	-----	-----

IMBALLO / EMBALLAGE
PACKAGING / VERPACKUNG

Lunghezza / Length / Longueur / Länge [mm]	1220	1370	1730	2220	3100
Profondità / Depth / Profondeur / Tiefe [mm]	1280	1280	1280	1280	1280
Altezza / Height / Hauteur / Höhe [mm]	1500	1500	1500	1500	1500

DROP IN (H250)

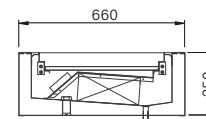

P 60

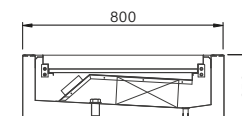

P 80

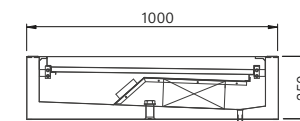

P 100

CON UNITÀ COLLEGATA

With connected condensing unit
Avec unité connectée
Mit angeschlossener kondensaggregat

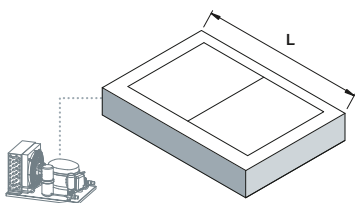

SENZA UNITÀ COLLEGATA

Without connected condensing unit
Sans unité connectée
Ohne angeschlossener kondensaggregat

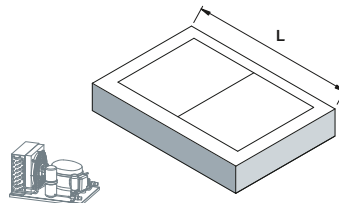

Mod.	L
------	---

100	1000
------------	------

125	1250
------------	------

150	1500
------------	------

200	2000
------------	------

250	2500
------------	------

Mod.	100	125	150	200	250
------	-----	-----	-----	-----	-----

PESO / WEIGHT POIDS / GEWICHT [kg]	87	91	117	160	205
---------------------------------------	----	----	-----	-----	-----

IMBALLO / EMBALLAGE
PACKAGING / VERPACKUNG

Lunghezza / Length / Longueur / Länge [mm]	1220	1370	1730	2220	3100
Profondità / Depth / Profondeur / Tiefe [mm]	1280	1280	1280	1280	1280
Altezza / Height / Hauteur / Höhe [mm]	1200	1200	1200	1200	1200

Mod.	100	125	150	200	250
------	-----	-----	-----	-----	-----

PESO / WEIGHT POIDS / GEWICHT [kg]	72	76	102	140	185
---------------------------------------	----	----	-----	-----	-----

IMBALLO / EMBALLAGE
PACKAGING / VERPACKUNG

Lunghezza / Length / Longueur / Länge [mm]	1220	1370	1730	2220	3100
Profondità / Depth / Profondeur / Tiefe [mm]	1280	1280	1280	1280	1280
Altezza / Height / Hauteur / Höhe [mm]	1200	1200	1200	1200	1200



PASTICCERIA CON RISERVA
Pastry with storage
Konditorei mit reserve
Pâtisserie avec réserve



PRALINERIA
Praline
Pralinerie
Pralinen



SOFT



+2 / +4 °C



3 (25°C - 60%UR)

H1220

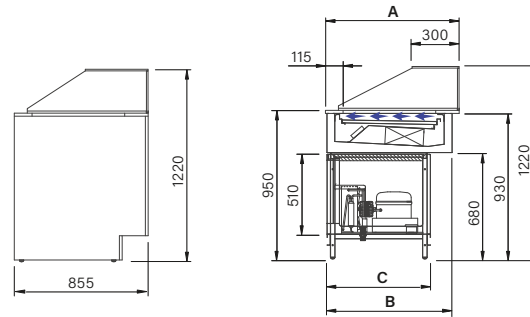

PROFONDITÀ / DEPTH / PROFONDEUR / TIEFE

	P 60	P 80	P100
A	715	855	1055
B	660	800	1000
C	660	660	720

150 SR

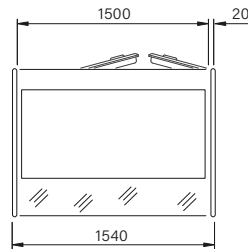

200 SR

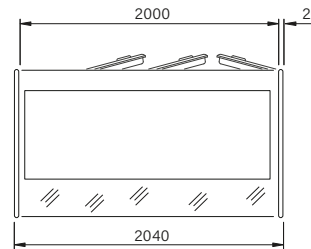

250 SR

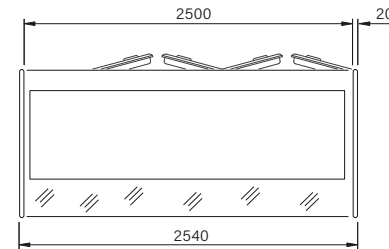

Mod.

150 SR

200 SR

250 SR

DIMENSIONI / DIMENSIONS / TAILLE / GRÖSSE

Lunghezza / Length / Longueur / Länge [mm]	1540	2040	2540
Profondità / Depth / Profondeur / Tiefe [mm]	A	A	A
Altezza / Height / Hauteur / Höhe [mm]	1220	1220	1220

PESO / WEIGHT / POIDS / GEWICHT [kg]

165	270	330
-----	-----	-----

IMBALLO / EMBALLAGE / PACKAGING / VERPACKUNG

Lunghezza / Length / Longueur / Länge [mm]	1730	2220	3100
Profondità / Depth / Profondeur / Tiefe [mm]	1280	1280	1280
Altezza / Height / Hauteur / Höhe [mm]	1500	1500	1500

POTENZA COMPRESSORE / POWER COMPRESSOR / PUISSANCE COMPRESSEUR / LEISTUNG VERDICHTER

(Monofase / Single-phase / Monophasé / Einphasig)

Tensione / Supply / Tension / Spannung [V/Ph/Hz]	230/1/50	230/1/50	230/1/50
Potenza assorbita / Electrical power output Puissance absorbée / Absorbierte Leistung [kW]	0,76	0,8	1,15
Sbrinatorio / In Defrost / Dégivrage / Zeitgesteuerte [kW]	-	-	-

H950

SENZA VETRI
Without glass
Sans verre
Ohne glas

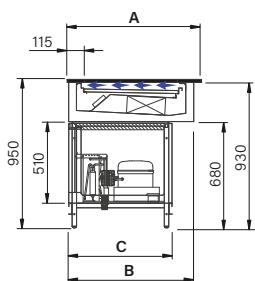

PROFONDITÀ / DEPTH
PROFONDEUR / TIEFE

	P 60	P80	P100
A	715	855	1055
B	660	800	1000
C	660	660	720

Mod.	150 SR	200 SR	250 SR
------	--------	--------	--------

PESO / WEIGHT POIDS / GEWICHT [kg]	145	245	295
--	-----	-----	-----

IMBALLO / EMBALLAGE / PACKAGING / VERPACKUNG

Lunghezza / Length / Longueur / Länge [mm]	1730	2200	3100
Profondità / Depth / Profondeur / Tiefe [mm]	1280	1280	1280
Altezza / Height / Hauteur / Höhe [mm]	1500	1500	1500

H930

SENZA VETRI E PIANO
Without glass and tray
Sans verre et plan
Ohne glas und ebne

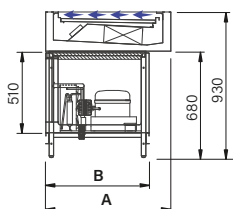

PROFONDITÀ / DEPTH
PROFONDEUR / TIEFE

	P 60	P80	P100
A	660	800	1000
B	660	660	720

Mod.	150 SR	200 SR	250 SR
------	--------	--------	--------

PESO / WEIGHT POIDS / GEWICHT [kg]	135	230	280
--	-----	-----	-----

IMBALLO / EMBALLAGE / PACKAGING / VERPACKUNG

Lunghezza / Length / Longueur / Länge [mm]	1730	2200	3100
Profondità / Depth / Profondeur / Tiefe [mm]	1280	1280	1280
Altezza / Height / Hauteur / Höhe [mm]	1500	1500	1500

H1220

FULL

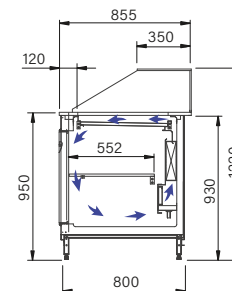
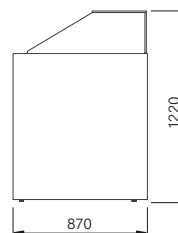

150 SF

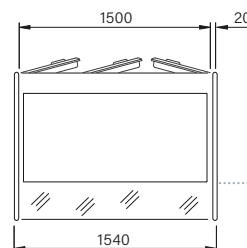

200 SF

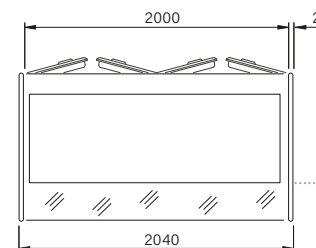

Mod.	150 SF	200 SF
------	--------	--------

DIMENSIONI / DIMENSIONS / TAILLE / GRÖSSE

Lunghezza / Length / Longueur / Länge [mm]	1540	2040
Profondità / Depth / Profondeur / Tiefe [mm]	855	855
Altezza / Height / Hauteur / Höhe [mm]	1220	1220

PESO / WEIGHT / POIDS / GEWICHT [kg]	140	254
---	-----	-----

IMBALLO / EMBALLAGE / PACKAGING / VERPACKUNG

Lunghezza / Length / Longueur / Länge [mm]	1730	2220
Profondità / Depth / Profondeur / Tiefe [mm]	1280	1280
Altezza / Height / Hauteur / Höhe [mm]	1500	1500

POTENZA COMPRESSORE / POWER COMPRESSOR / PUISSANCE COMPRESSEUR / LEISTUNG VERDICHTER

(Monofase / Single-phase / Monophasé / Einphasig)		
Tensione / Supply / Tension / Spannung [V/Ph/Hz]	230/1/50	230/1/50
Potenza assorbita / Electrical power output Puissance absorbée / Absorbierte Leistung [kW]	0,76	0,8
Sbrinatorio / In Defrost / Dégivrage / Zeitgesteuerte [kW]	-	-



CALDO A SECCO
Dry heat
Chaud à sec
Trockene Wärme



H1220

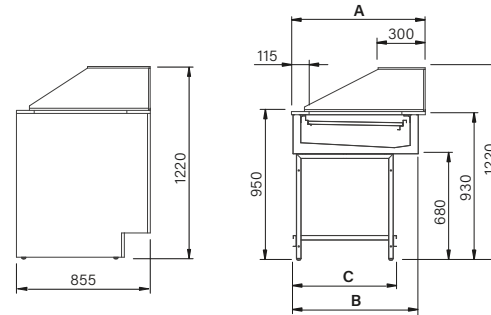

PROFONDITÀ / DEPTH / PROFONDEUR / TIEFE

	P 60	P80	P100
A	715	855	1055
B	660	800	1000
C	660	660	720

100

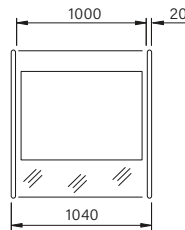

125

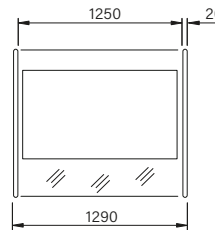

150

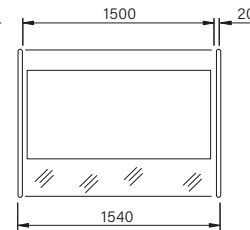

200

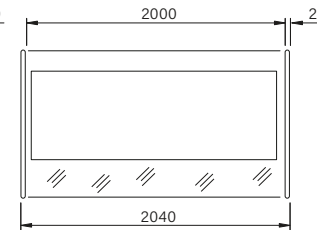

250

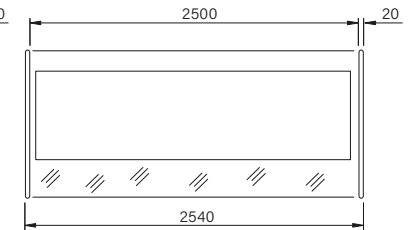

Mod.	100	125	150	200	250
DIMENSIONI / DIMENSIONS / TAILLE / GRÖSSE					
Lunghezza / Length / Longueur / Länge [mm]	1040	1290	1540	2040	2540
Profondità / Depth / Profondeur / Tiefe [mm]	A	A	A	A	A
Altezza / Height / Hauteur / Höhe [mm]	1220	1220	1220	1220	1220
PESO / WEIGHT / POIDS / GEWICHT [kg]					
	130	134	175	215	255
IMBALLO / EMBALLAGE / PACKAGING / VERPACKUNG					
Lunghezza / Length / Longueur / Länge [mm]	1220	1370	1730	2220	3100
Profondità / Depth / Profondeur / Tiefe [mm]	1280	1280	1280	1280	1280
Altezza / Height / Hauteur / Höhe [mm]	1500	1500	1500	1500	1500
POTENZA COMPRESSORE / POWER COMPRESSOR / PUISSANCE COMPRESSEUR / LEISTUNG VERDICHTER					
(Monofase / Single-phase / Monophasé / Einphasig)					
Tensione / Supply / Tension / Spannung [V/Ph/Hz]	230/1/50	230/1/50	230/1/50	230/1/50	230/1/50
Potenza assorbita / Electrical power output	0,6	0,6	1,2	1,8	2,4
Puissance absorbée / Absorbierte Leistung [kW]	-	-	-	-	-
Sbrinamento / In Defrost / Dégivrage / Zeitgesteuerte [kW]	-	-	-	-	-



+40 / +60 °C

H950

SENZA VETRI
Without glass
Sans verre
Ohne glas

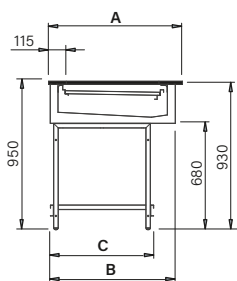

PROFONDITÀ / DEPTH
PROFONDEUR / TIEFE

	P 60	P80	P100
A	715	855	1055
B	660	800	1000
C	660	660	720

H930

SENZA VETRI E PIANO
Without glass and tray
Sans verre et plan
Ohne glas und ebne

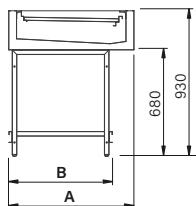

PROFONDITÀ / DEPTH
PROFONDEUR / TIEFE

	P 60	P80	P100
A	660	800	1000
B	660	660	720

DROP IN (H250)



P 60

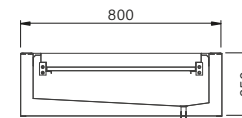

P 80

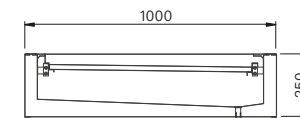

P 100

Mod. 100 125 150 200 250

PESO / WEIGHT
POIDS / GEWICHT [kg] 110 114 155 195 235

IMBALLO / EMBALLAGE
PACKAGING / VERPACKUNG

Lunghezza / Length / Longueur / Länge [mm] 1220 1370 1730 2220 3100
Profondità / Depth / Profondeur / Tiefe [mm] 1280 1280 1280 1280 1280
Altezza / Height / Hauteur / Höhe [mm] 1500 1500 1500 1500 1500

Mod. 100 125 150 200 250

PESO / WEIGHT
POIDS / GEWICHT [kg] 100 104 145 185 225

IMBALLO / EMBALLAGE
PACKAGING / VERPACKUNG

Lunghezza / Length / Longueur / Länge [mm] 1220 1370 1730 2220 3100
Profondità / Depth / Profondeur / Tiefe [mm] 1280 1280 1280 1280 1280
Altezza / Height / Hauteur / Höhe [mm] 1500 1500 1500 1500 1500

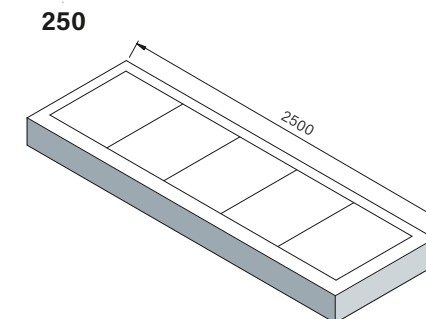
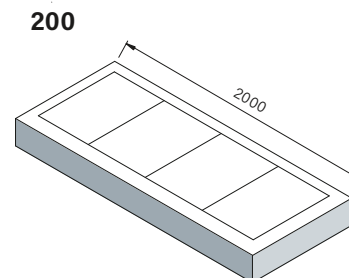
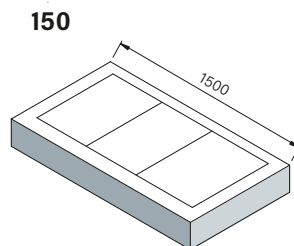
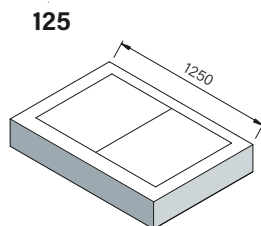
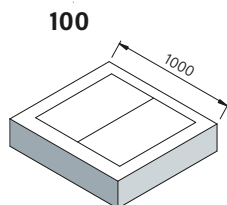

Mod. 100 125 150 200 250

PESO / WEIGHT / POIDS / GEWICHT [kg] 72 76 102 140 185

IMBALLO / EMBALLAGE / PACKAGING / VERPACKUNG

Lunghezza / Length / Longueur / Länge [mm] 1220 1370 1730 2220 3100
Profondità / Depth / Profondeur / Tiefe [mm] 1280 1280 1280 1280 1280
Altezza / Height / Hauteur / Höhe [mm] 1200 1200 1200 1200 1200



BAGNO MARIA
Bain marie
Bain-marie
Wasserbad



H1220

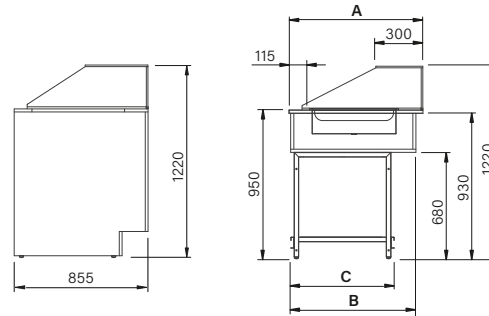

PROFONDITÀ / DEPTH / PROFONDEUR / TIEFE

	P 60	P 80	P 100
A	715	855	1055
B	660	800	1000
C	660	660	720

100

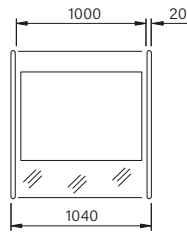

125

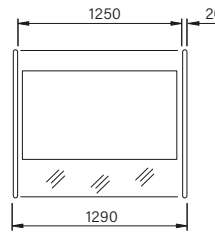

150

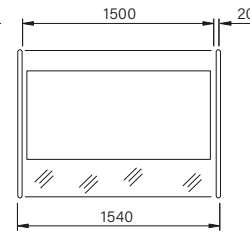

200

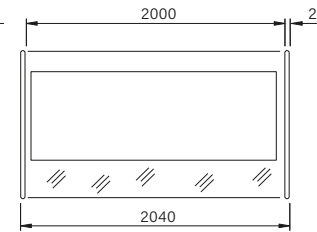

250

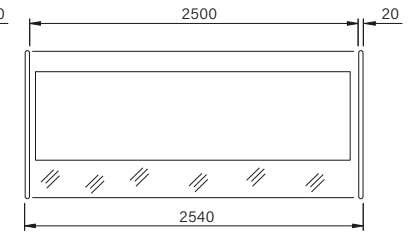

Mod.	100	125	150	200	250
DIMENSIONI / DIMENSIONS / TAILLE / GRÖSSE					
Lunghezza / Length / Longueur / Länge [mm]	1040	1290	1540	2040	2540
Profondità / Depth / Profondeur / Tiefe [mm]	A	A	A	A	A
Altezza / Height / Hauteur / Höhe [mm]	1220	1220	1220	1220	1220
PESO / WEIGHT / POIDS / GEWICHT [kg]	130	134	175	215	255
IMBALLO / EMBALLAGE / PACKAGING / VERPACKUNG					
Lunghezza / Length / Longueur / Länge [mm]	1220	1370	1730	2220	3100
Profondità / Depth / Profondeur / Tiefe [mm]	1280	1280	1280	1280	1280
Altezza / Height / Hauteur / Höhe [mm]	1500	1500	1500	1500	1500
POTENZA COMPRESSORE / POWER COMPRESSOR / PUISSANCE COMPRESSEUR / LEISTUNG VERDICHTER					
(Monofase / Single-phase / Monophasé / Einphasig)					
Tensione / Supply / Tension / Spannung [V/Ph/Hz]	230/1/50	230/1/50	230/1/50	230/1/50	230/1/50
Potenza assorbita / Electrical power output					
Puissance absorbée / Absorbierte Leistung [kW]	1,5	1,5	2,4	3	4,5
Sbrinamento / In Defrost / Dégivrage / Zeitgesteuerte [kW]	-	-	-	-	-



+40 / +90 °C

H950

SENZA VETRI
Without glass
Sans verre
Ohne glas

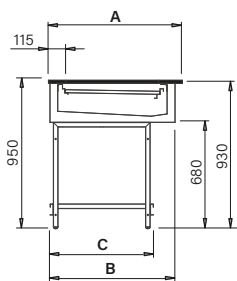

PROFONDITÀ / DEPTH
PROFONDEUR / TIEFE

	P 60	P80	P100
A	715	855	1055
B	660	800	1000
C	660	660	720

DROP IN (H250)

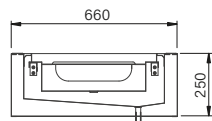

P 60

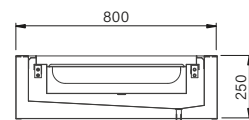

P 80

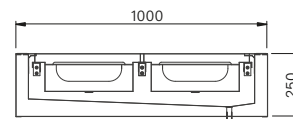

P 100

Mod. 100 125 150 200 250

PESO / WEIGHT
POIDS / GEWICHT [kg] 110 114 155 195 235

IMBALLO / EMBALLAGE
PACKAGING / VERPACKUNG

Lunghezza / Length / Longueur / Länge [mm] 1220 1370 1730 2220 3100
Profondità / Depth / Profondeur / Tiefe [mm] 1280 1280 1280 1280 1280
Altezza / Height / Hauteur / Höhe [mm] 1500 1500 1500 1500 1500

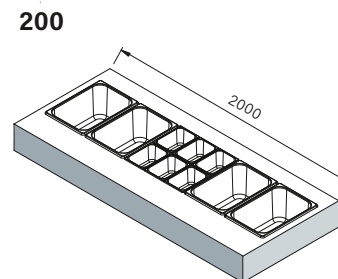
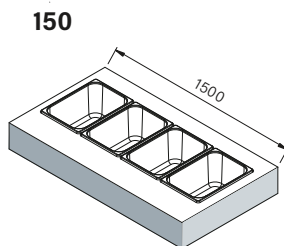
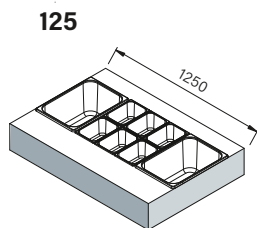
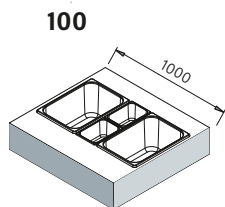

VASCHE / CONTAINERS / CONTENEURS / SCHALEN

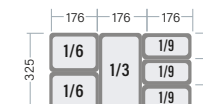
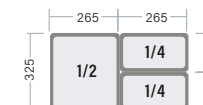
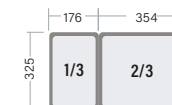
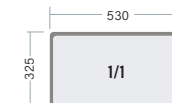
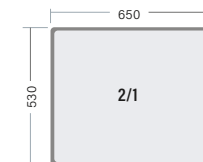

Mod. 100 125 150 200

PESO / WEIGHT / POIDS / GEWICHT [kg] 72 76 102 140

IMBALLO / EMBALLAGE / PACKAGING / VERPACKUNG

Lunghezza / Length / Longueur / Länge [mm] 1220 1370 1730 2220
Profondità / Depth / Profondeur / Tiefe [mm] 1280 1280 1280 1280
Altezza / Height / Hauteur / Höhe [mm] 1200 1200 1200 1200

H1220

NEUTRO
Neutral
Neutral
Neutre

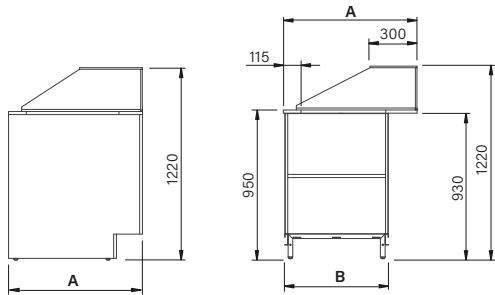

PROFONDITÀ / DEPTH
PROFONDEUR / TIEFE

	P 60	P80	P100
A	715	855	1055
B	660	660	720

H950

BANCO CASSA
Cash counter
Kassentheke
Tiroir caisse



60



80

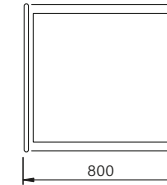

100

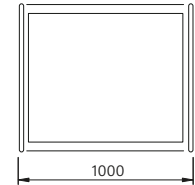

100

125

150

200

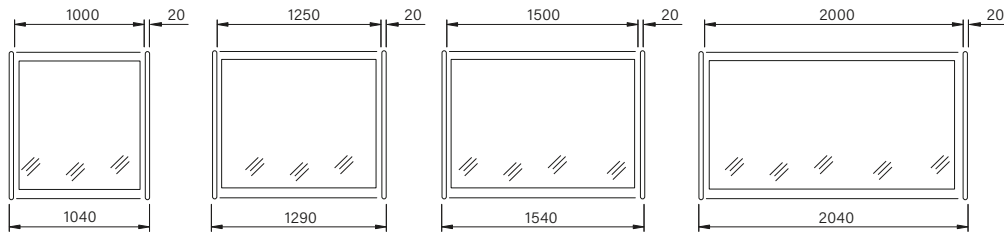

H950

BANCO CASSA PER PORTATORI DI HANDCAP
Cash counter for handicapped
Kassentheke für behinderte
Tiroir caisse pour handicapé

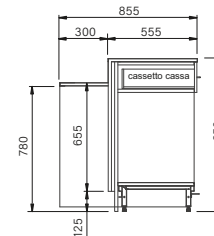

60

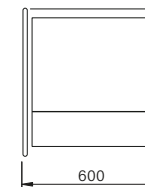

80

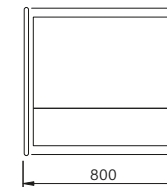

100

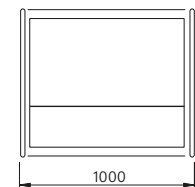

Mod.	100	125	150	200
------	-----	-----	-----	-----

DIMENSIONI / DIMENSIONS / TAILLE / GRÖSSE

Lunghezza / Length / Longueur / Länge [mm]	1040	1290	1540	2040
Profondità / Depth / Profondeur / Tiefe [mm]	A	A	A	A
Altezza / Height / Hauteur / Höhe [mm]	1220	1220	1220	1220

PESO / WEIGHT / POIDS / GEWICHT [kg]	120	125	160	200
--------------------------------------	-----	-----	-----	-----

IMBALLO / EMBALLAGE / PACKAGING / VERPACKUNG

Lunghezza / Length / Longueur / Länge [mm]	1220	1370	1730	2220
Profondità / Depth / Profondeur / Tiefe [mm]	1280	1280	1280	1280
Altezza / Height / Hauteur / Höhe [mm]	1500	1500	1500	1500

Mod.	60	80	100
------	----	----	-----

DIMENSIONI / DIMENSIONS / TAILLE / GRÖSSE

Lunghezza / Length / Longueur / Länge [mm]	600	800	1000
Profondità / Depth / Profondeur / Tiefe [mm]	855	855	855
Altezza / Height / Hauteur / Höhe [mm]	950	950	950

PESO / WEIGHT / POIDS / GEWICHT [kg]	75	80	85
--------------------------------------	----	----	----

IMBALLO / EMBALLAGE / PACKAGING / VERPACKUNG

Lunghezza / Length / Longueur / Länge [mm]	1220	1220	1220
Profondità / Depth / Profondeur / Tiefe [mm]	1280	1280	1280
Altezza / Height / Hauteur / Höhe [mm]	1200	1200	1200

Sono disponibili moduli in varie soluzioni e dimensioni
Units are available in various solutions and sizes
Les modules sont disponibles en différentes solutions et tailles
Modelle sind in verschiedenen Lösungen und Größen erhältlich

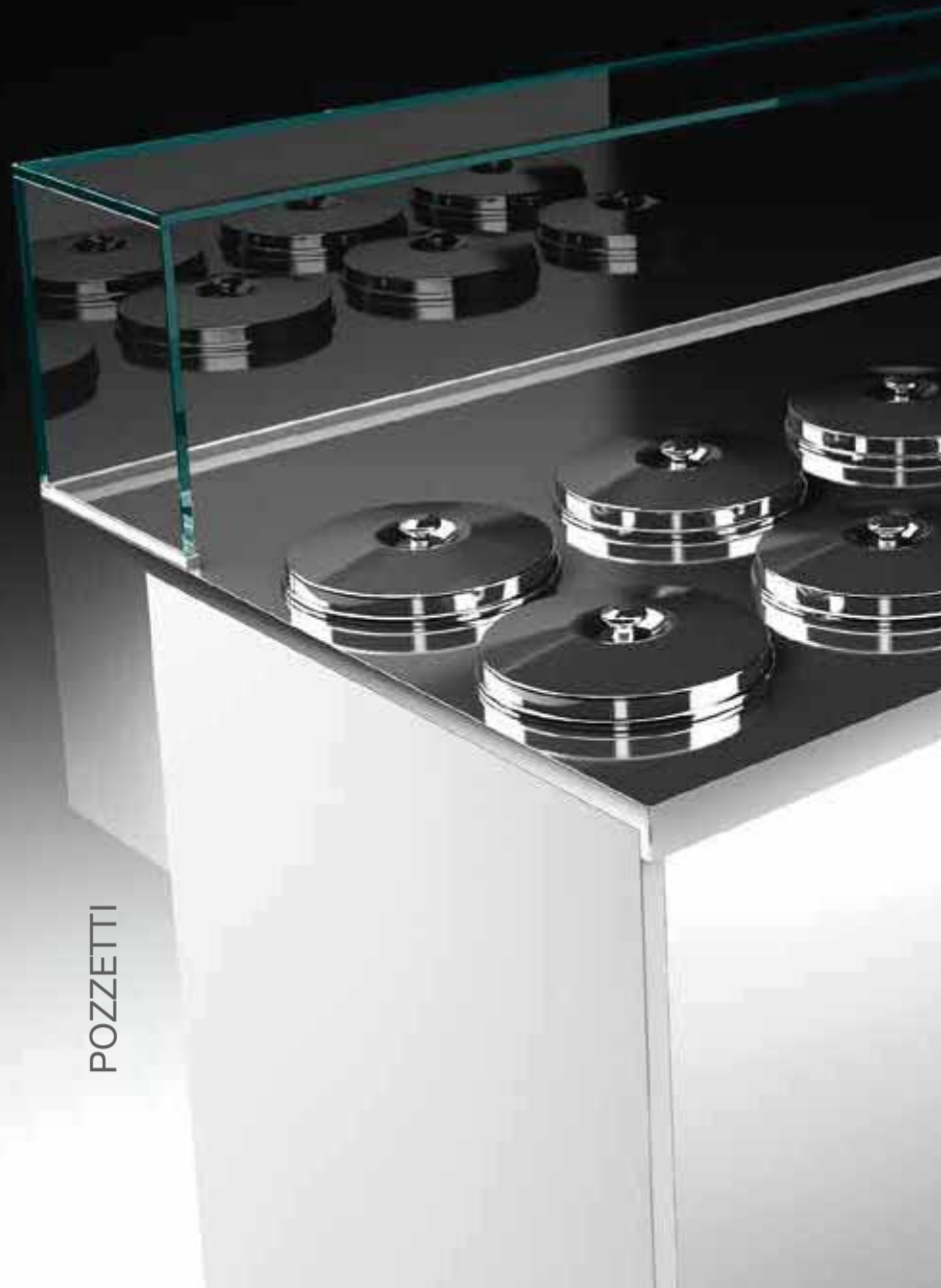

POZZETTI



TOPPING



Follow us
Italproget



ITALPROGET

Via Ponte di Ferro 85 – 06084 Bettona PG

Telefono: +39 075 987038

Fax: +39 075 987016

Email: info@italproget.it

www.italproget.it